

1

Connectors

M series

Circular modular
connectors

Installation and maintenance
instructions

Manual A10-M.en

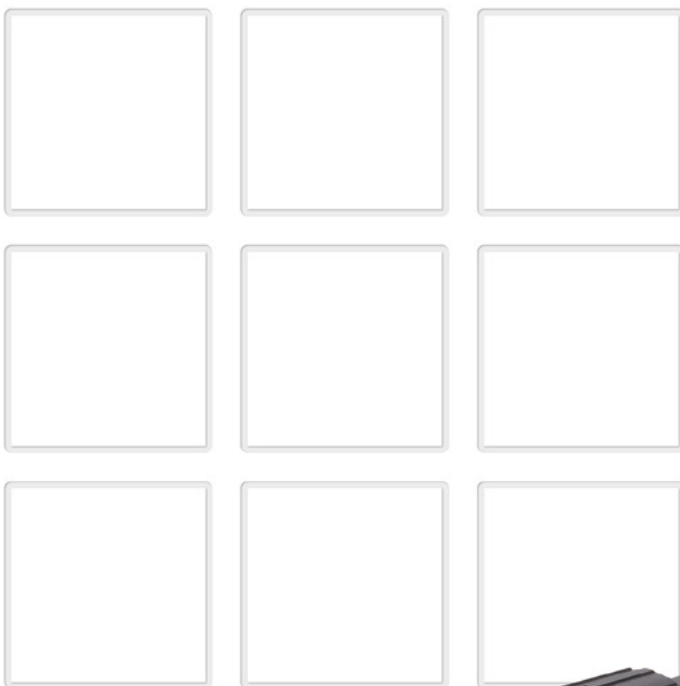

Content

1. Important Basic Information	3
1.1 Legal Notes.....	3
1.2 Conventions for this Installation and Maintenance Instructions.....	3
2. General and Security Information	3
2.1 Observing the Installation and Maintenance Instructions	3
2.2 User Obligations.....	3
2.3 Intended Use.....	4
2.4 Ambient Conditions.....	4
3. Dangers and Security Measures	5
3.1 Electrical Dangers	5
3.2 Other Hazards.....	5
3.3 Measures for Avoiding Damages.....	6
3.4 Measures for Avoiding Malfunctions	6
4. Description.....	7
4.1 Features	7
4.2 Varieties of Configuration	7
4.3 Survey of the Components.....	8
5. Installation	10
5.1 Check Parts for Transport Damage	10
5.2 Assembly of Receptacles / Plugs into a Mounting Wall	10
6. Cable Assembly and Processing	12
6.1 Required Tools.....	12
6.2 Crimp Contacts (Pin / Socket) and Filler Plugs	13
6.3 Ordering Code for Contacts	14
6.4 Threading Parts on Cables	14
6.5 Make Crimp Connections.....	16
6.6 Assemble Contacts into Contact Inserts.....	17
6.7 Assemble Filler Plugs	18
6.8 Assemble Contact Inserts into Receptacle / Plug shells	18
6.9 Final Assembly of the Connectors.....	20
7. Plugging Procedure.....	22
7.1 Plugging	22
7.2 Unplugging	23
7.3 Attach Protection Caps	23
8. Regular Visual Checks / Functional Checks	25
8.1 Checking Intervals.....	25
8.2 Visual and Functional Check with Every Plugging Procedure	25
9. Special Tools and Spare Parts	27
10. Technical Data	27

1. Important Basic Information

1.1 Legal Notes

Without prior written consent of Schaltbau GmbH, the installation and maintenance instructions is not allowed to be electronically or mechanically reproduced – as a whole or in parts – be distributed, changed, transmitted, translated into another language or used in any other way.

Schaltbau GmbH cannot be held liable for damage caused by not observing (or only partly observing) the Installation and maintenance instructions.

1.2 Conventions for this Installation and Maintenance Instructions

This instructions describe the installation and maintenance of the M series connectors.

Cross references are presented in *bold italics*.

To highlight particularly important safety instructions and other information, the following symbols are used in this instructions:

⚠ DANGER
Indicates a hazardous situation with a high level of risk which, if not avoided, will result in death or serious injury.

⚠ WARNING
Indicates a hazardous situation with a medium level of risk which, if not avoided, could result in death or serious injury.

⚠ CAUTION
Indicates a hazardous situation with a low level of risk which, if not avoided, may result in minor or moderate injury.

NOTICE
Indicates a hazardous situation which, if not avoided, may result in property damage, such as service interruption or damage to equipment or other materials.

	Refers to technical features and methods aimed at facilitating work or to particularly important information.
--	---

2. General and Security Information

The circular industrial connectors dealt with in this document are intended for use with low-voltage systems for special applications. They are designed and tested in compliance with the generally recognised state of the art. However, the improper use, operation, handling, maintenance of or tampering with electric equipment can cause serious or fatal injury to the user or others, and the appliance or other property can be damaged.

The operation, maintenance and installation instructions for the connectors must therefore be strictly followed.

Any uncertainties must be clarified and all queries must include details of the type of device and the serial number.

Only authorized and trained personnel are allowed to plan and carry out all mechanical and electrical installations, transport, commissioning, as well as maintenance and repair work. This applies to the observation of the general installation and safety regulations for low-voltage systems as well as the proper use of tools approved for this purpose. Electric equipment requires protection from moisture and dust during installation and storage.

2.1 Observing the Installation and Maintenance Instructions

- ▶ All staff must read and understand the instructions and adhere to them when working with the device.
- ▶ Always carefully observe all safety warnings!

2.2 User Obligations

- ▶ Observe the respective national instructions and the other applicable safety regulations for the use and cable assembly of connectors and connector systems.
- ▶ Observe all applicable national provisions, all safety, accident prevention and environmental regulations as well as the recognized technical rules for safe and proper working.
- ▶ Carry out regular inspections of all protection and safety devices to see if they work properly.

- ▶ Work on electric equipment may only be performed by an expert or trained personnel working under the direction and supervision of an expert according to the applicable rules of electrical engineering.
- ▶ An expert is a person who can judge and recognise the possible dangers of the jobs commended to him based on his training, knowledge and experience and by knowledge of the appropriate regulations.
- ▶ Staff must be informed clearly about who is responsible for the maintenance of the connectors.

2.3 Intended Use

- ▶ The connectors supply power and signals. They are intended for plugin and detachable connections of components, devices and systems only.
- ▶ In order to comply with DIN EN IEC 61984 make sure that always the live side of the connector – no matter whether plug or receptacle – is fitted with socket contacts.
- ▶ A symmetrical assembly of the contact insert is not permitted. Please refer to the chapter „6. Cable Assembly and Processing“.
- ▶ None of the operating conditions defined in our catalogue “A10.en” in section “Specifications”, such as voltages, currents, ambient conditions, etc. may be changed.
- ▶ Work on the connectors must only be carried out by staff who meets the requirements set out in these installation and maintenance instructions.
- ▶ According to DIN EN IEC 61984 connectors used as intended must not be engaged or disengaged when live or under load.
- ▶ A connector that does not engage easily requires special attention:
Check for the correct orientation, pollution or if contacts got bent. Remedy the cause without delay. Never use force! The connector should always engage easily.

- ▶ In order to meet the requirements of the protection class and to prevent the connectors against the entry of dirt or moisture, make sure that plugs and receptacles, when not mated, are always closed with protection caps.
- ▶ When disengaging a connector, pull the plug and never the cable.
- ▶ Use the connector only according to its intended use. Replace or repair damaged parts exclusively with original parts. Any other usage of or tampering with the connector is considered contrary to its intended use. No liability is assumed for damages and accidents caused due to non-compliance with the instructions or improper use of the connector.

2.4 Ambient Conditions

NOTICE

The connectors are constructed for specific ambient conditions.

- ▶ Operate the connectors only under the ambient conditions, like temperature ranges and IP protection classes as defined in our catalogue **A10.en** in section “Specifications” (schaltbau.info/download1en).



Note:



In case of a very low or very high ambient temperature which approximates the limits of the allowable operating temperature range specified in our catalogue **A10.en** in section “Specifications”,

- a higher effort may be needed for the plugging and unplugging and
- the operational life span of plug and coupling receptacle may thus be reduced due to increased wear and tear.



3. Dangers and Security Measures



3.1 Electrical Dangers

	 DANGER
	<p>The connectors contain components that carry voltage. Deadly hazard! Always observe the following safety regulations before beginning any work on electrical constructions:</p> <ul style="list-style-type: none"> ▶ Disconnect ▶ Ensure that it is not possible to reconnect unintentionally ▶ Clearly mark your work area ▶ Make sure that there is no voltage present ▶ Earth and short circuit the installation ▶ Insulate or cover adjacent energized parts ▶ Only an electrically skilled person may determine if there is no voltage present

	 WARNING
	<p>A wrong pin configuration of the contact inserts may cause a deathly electric shock.</p> <ul style="list-style-type: none"> ▶ Make sure that associated pin contacts and socket contacts are always inserted in the corresponding contact cavities with identical pin configuration! ▶ Make sure that contacts with phase assignment are not mounted into contact cavities which are destined for the protective earthing (PE) contact! ▶ Refer to chapter „6. Cable Assembly and Processing“.

3.2 Other Hazards

	 WARNING
	<p>Exclusively use the connectors for purposes as indicated in the specifications and data sheets. A wrong application can cause accidents and severe damages to persons.</p> <ul style="list-style-type: none"> ▶ The manufacturer doesn't take the responsibility for accidents which were caused by improper use of the product. ▶ We recommend the use of fault current safety systems in constructions with voltages higher than safety extra-low voltage.

 	 WARNING
	<p>The plugging and disconnecting of the connectors on-load can cause electric arcs. When explosive substances or ignition sources of any kind are nearby, there is a risk of fire and explosion!</p> <ul style="list-style-type: none"> ▶ Never plug and disconnect the connectors on-load.

3.3 Measures for Avoiding Damages

NOTICE

Improper handling of the connector, e.g. when hitting the floor with some impact, can result in breakage, visible cracks and deformation.

- ▶ Make sure that the connectors are handled appropriately.
- ▶ Carry out regular visual checks to detect possible damages.
- ▶ Replace damaged parts immediately.

3.4 Measures for Avoiding Malfunctions

NOTICE

In the case of damage, wear and tear and/or soiling of the connector components - in the form of a partial break, sharp edges and discoloured surfaces - the functional safety of the connectors is no longer guaranteed.

- ▶ Carry out regular visual checks to detect wear and tear and dirt.
- ▶ Immediately replace damaged parts.
- ▶ Immediately remove dirt without leaving any residues.
- ▶ Immediately replace parts with stubborn dirt.

NOTICE

Inappropriate handling when plugging or disconnecting may damage the connectors. The functional safety of the connectors is no longer guaranteed when parts are damaged.

- ▶ Make sure that the guideways and slots of plug and receptacle always interlock when plugging!
- ▶ Take care that plug and receptacle do not tilt and that they are plugged without force.
- ▶ Make sure before the plugging procedure that plug and receptacle as well as the protection caps are not soiled. Remove existent dirt without leaving any residues.
- ▶ Make sure that in the not mated condition the protection caps are always attached according to regulations.

4. Description

Connectors of the M series are universal industry connectors and offer high reliability.

M1 and M3 connectors are dust-proof and water pressure tight (protection class IP67 when mated and IP69K when not mated with screwed on protection cap). Moreover, they are largely resistant to acids and alkalines as well as to heat and cold.

There is a large application range. Typical applications are systems and components where reliability under difficult circumstances is important, e.g. in mining, shipbuilding, power plant construction, mechanical and traffic engineering, environmental technology or in food processing.

Connectors of the M series have a modular design which offers a wide range of applications.

4.1 Features

Common features of M1 and M3 series connectors:

- ▶ **Modular design:** Customized and cost-effective realisation of your application.
- ▶ **Shells:** Various kinds of assembly, e.g. plug and receptacle shells with and without strain relief, with flange, for use with heat shrink boots or backshells with thread and cable gland, also flange-mount angled receptacle. Materials used:
 - Fibre glass reinforced polyamide: impact resistant
 - Non-halogen, UL listed
- ▶ **Design flexibility:** Plug and receptacle shell can be fitted with either pin or socket insert, i.e. fully insulated socket inserts can be mounted on the live part.
- ▶ **Orientation:** Pin and socket inserts can be located in the shell in two different positions, thus preventing mismatching. It also allows for the unmistakable connection of for example two connectors with different voltages to one and the same piece of equipment.
- ▶ **Contacts:**
 - High-quality screw machine contacts
 - Silver or gold plated
 - Crimp connection depending on series and contact arrangement from 0.5 ... 6 mm².

Special features of M1 series:

- ▶ Number of contacts: 4 and 6 + PE
- ▶ 5.000 mating cycles at constant low contact resistance
- ▶ Current rating: 16 A max

Special features of M3 series:

- ▶ Number of contacts: 6 + PE, 5+3 + PE, 12 +PE and 7+7 + PE
- ▶ 5.000 mating cycles at constant low contact resistance
- ▶ Current rating: 50 A max

4.2 Varieties of Configuration

On the next pages you can find a survey of the extensive varieties of configuration of the different connector components for the M1 and M3 series. The survey shows how the components listed below may be combined with each other:

- ▶ Plug shells
- ▶ Receptacle shells
- ▶ Inserts and types of contacts
- ▶ Cable sleeves, shrink boots
- ▶ Backshells
- ▶ Cable glands
- ▶ Protection caps

Under the following link on our homepage you can moreover find a configurator with the help of which you can assemble the various connector components in a comfortable way:

www.schaltbau-gmbh.com/en/Products/Connectors/M-series/

In order to find the configurator, click on the symbol with the two gears under the desired series on our homepage:



4.3 Survey of the Components

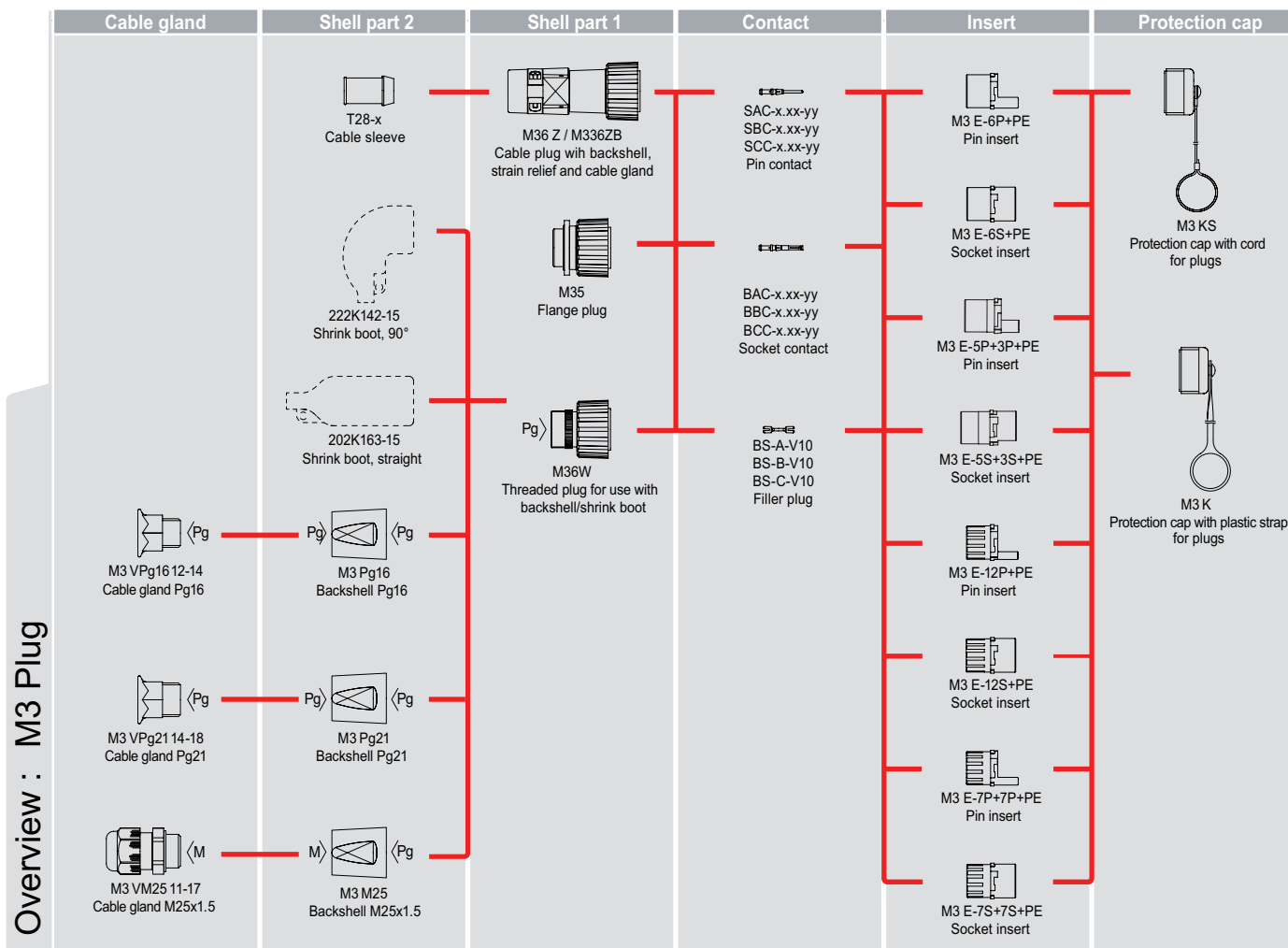
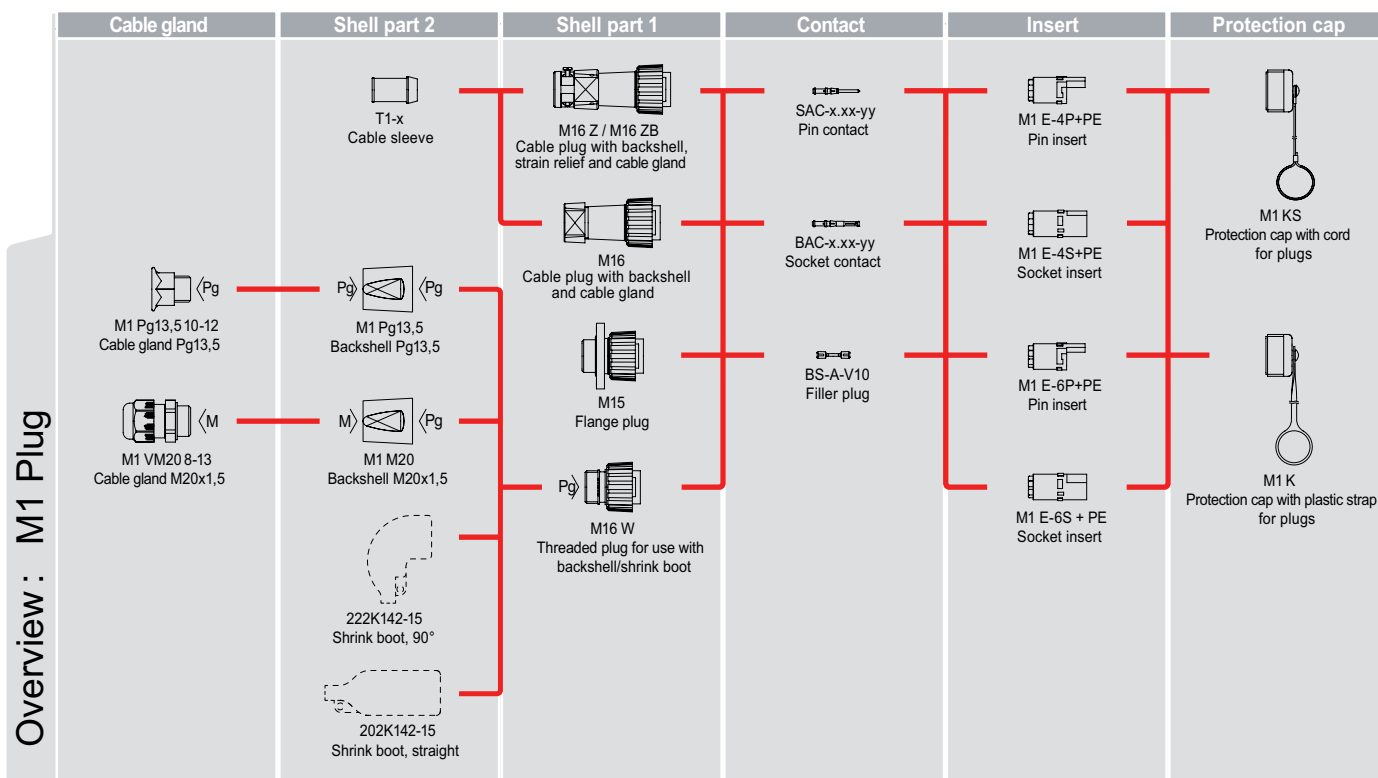

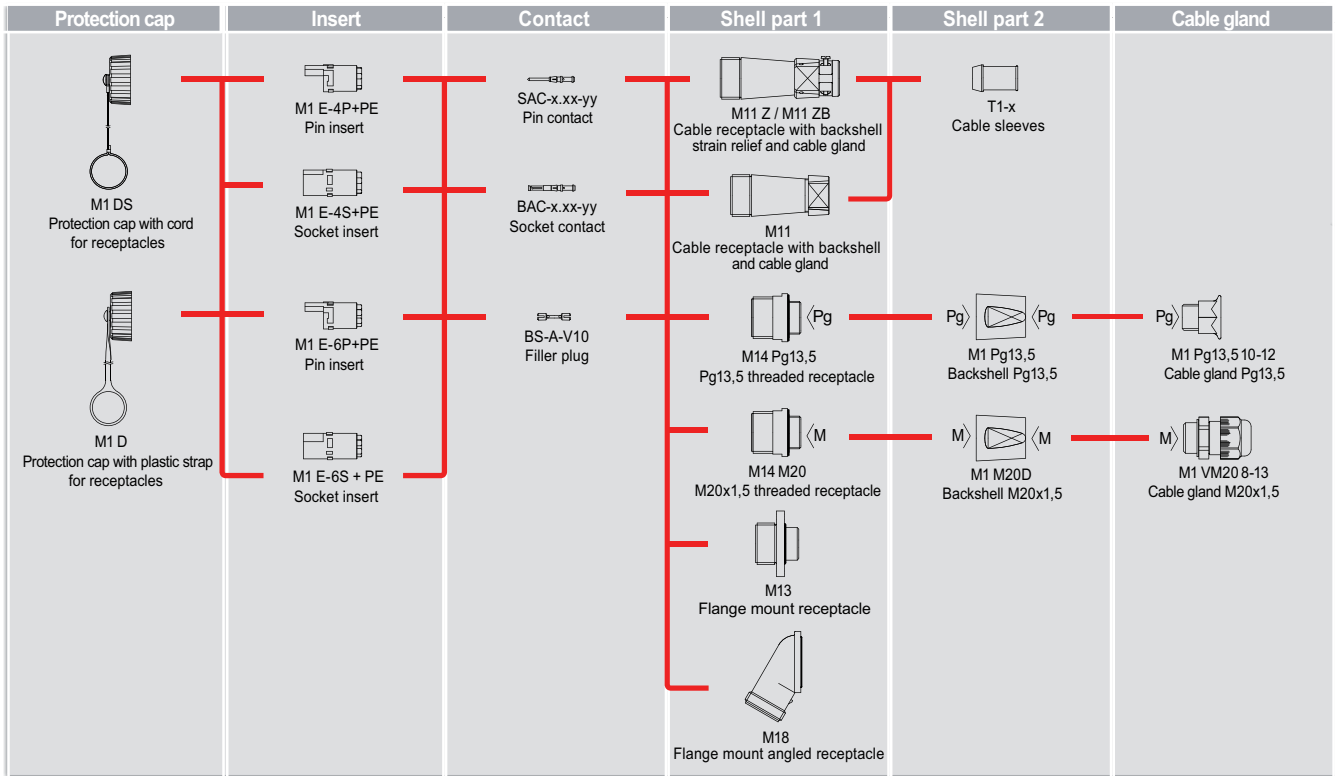

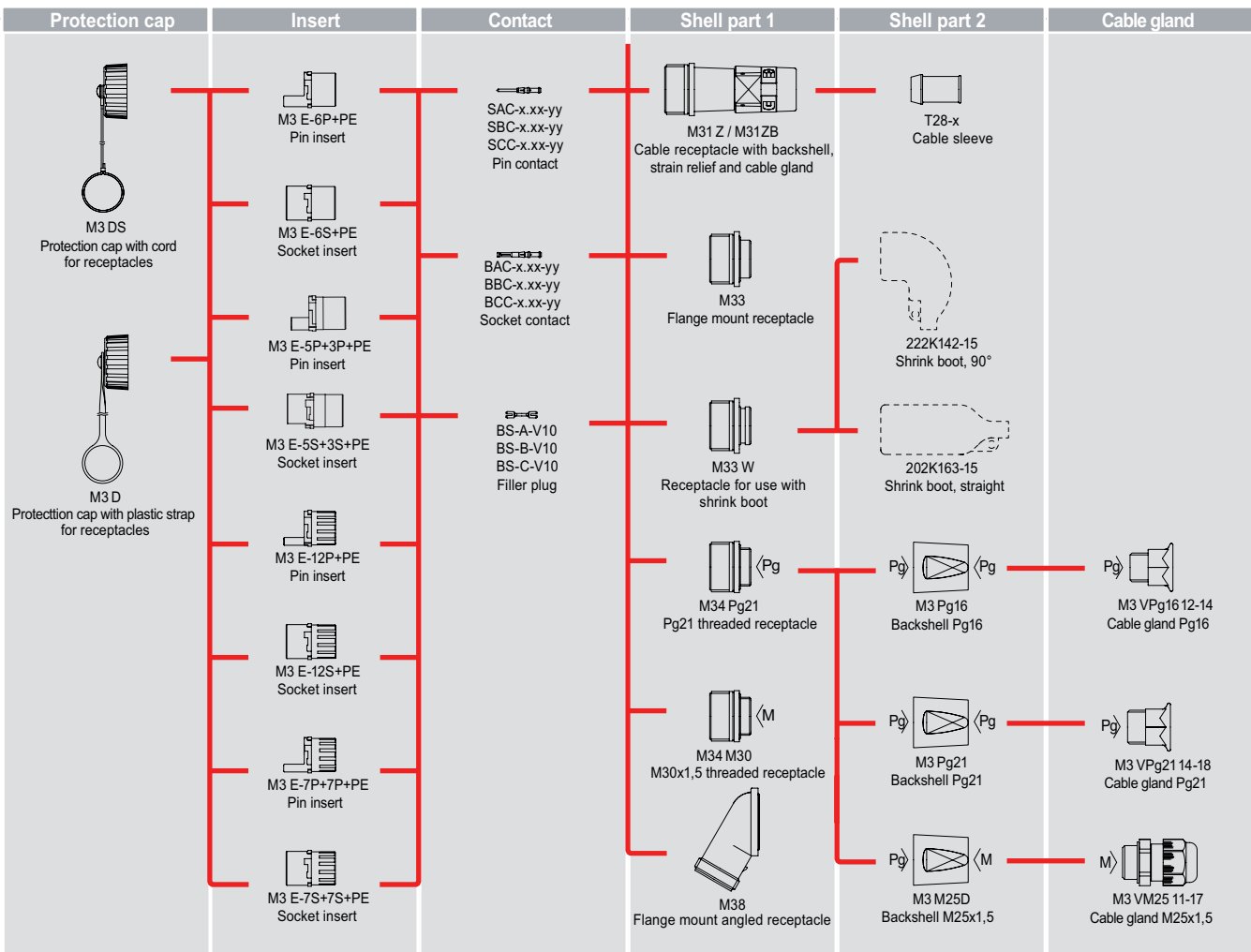

Overview : M1 Receptacle



Overview : M3 Receptacle

5. Installation

 DANGER	
	<p>The connectors contain components that carry voltage. Deadly hazard! Always observe the following safety regulations before beginning any work on electrical constructions:</p> <ul style="list-style-type: none"> ▶ Disconnect ▶ Ensure that it is not possible to reconnect unintentionally ▶ Clearly mark your work area ▶ Make sure that there is no voltage present ▶ Earth and short circuit the installation ▶ Insulate or cover adjacent energized parts ▶ Only an electrically skilled person may determine if there is no voltage present

NOTICE
<p>During installation, ensure that dirt caused by surrounding construction activities does not get into the connectors.</p>

5.1 Check Parts for Transport Damage

NOTICE
<p>The functional safety of the connectors is no longer guaranteed when parts are damaged.</p> <ul style="list-style-type: none"> ▶ Before installing, check all parts for any possible transport damage. ▶ Do not install any damaged parts.

Series	Model of receptacle / plug	Size of screw (number)
M1	Receptacle/plug with flange	M3 (2x)
	Angle receptacle with flange	M3 (4x)
M3	Receptacle/plug with flange and angle receptacle with flange	M4 (4x)

5.2 Assembly of Receptacles / Plugs into a Mounting Wall

Preparing measures

Appropriate mounting holes have to be prepared depending on the model for the mounting of receptacles and plugs with flange or thread into a mounting wall (refer to section „*Mounting holes / thread*“). In order to relieve the contacts from strain when assembled, a strain relief has to be provided on the mounting wall.

Fastening of receptacles / plugs with flange

For the fastening of receptacles and plugs with flange you need screws according to the following table:

The length of the fastening screws as well as appropriate thread locker elements have to be determined according to the assembly situation. The torque has to be determined according to the screws used and to the materials existing on the site of the assembly.

Fastening of receptacles / plugs with thread

For the fastening of receptacles with thread, corresponding threads have to be prepared in the mounting wall.

Torque for all receptacles with thread: 2.5 Nm.

Dimensions

The measures for the different receptacles and plugs with flange or thread may be taken from the following table:

	Model of receptacle / plug (diagrams not true to scale)	Dimensions [mm]	
		Series M1	Series M3
Flange mount receptacles		M13 a = 27 b = 18 c = Ø 20,4 d = Ø 30 e = Tr26x2 f = 41 g = Ø 3,2 h = 34 x = Immersion depth 13,5	M33 a = 31,5 b = 22,7 c = Ø 29 j = Tr38x6 P3 k = □ 32,5 m = □ 42 n = Ø 4,3 x = Immersion depth 15
Flange mount angled receptacles		M18 a = Tr26x2 b = □ 30,5 c = □ 38,5 d = Ø 3,4 e = 65 max. f = 35,5 g = 58 h = 115 max	M38 a = Tr38x6 P3 b = □ 43,5 c = □ 51,5 d = Ø 4,3 e = 95 max. f = 53,5 g = 87 h = 150 max
Flange mount plugs		M15 a = 37,5 b = 28,5 c = Ø 20,4 d = Ø 31 e = Tr26x2 f = 34 g = 41 h = Ø 3,2	M35 a = 43,5 b = 34,5 c = Ø 29 j = Tr38x6 P3 k = □ 32,5 m = □ 42 n = Ø 4,3 p = Ø 45
Receptacles with thread		M14 a = 31,5 b = 22,5 c/d = Pg13,5/M20x1,5 e = Ø 30 f = Tr26x2 g = SW 27 x = Immersion depth 13,5	M34 a = 31,5 b = 22,7 c/d = Pg21/M30x1,5 e = Ø 40 f = Tr38x6 P3 g = SW 38 x = Immersion depth 15
Plugs with thread		M16W a = 35,8 b = 3,5 c = Ø 19 d = Pg 13,5 e = Ø 21,4 f = 1 g = 12,5 h = Tr26x2 j = Ø 31	M36W a = 46,5 b = 3,5 c = Ø 27 d = Pg 21 e = Ø 29 f = 5,5 g = 26,5 h = Tr38x6 P3 j = Ø 45

Mounting holes / thread

You may take the measures for the mounting holes for the assembly of the different receptacles and plugs with flange or thread into a mounting wall from the following diagram.

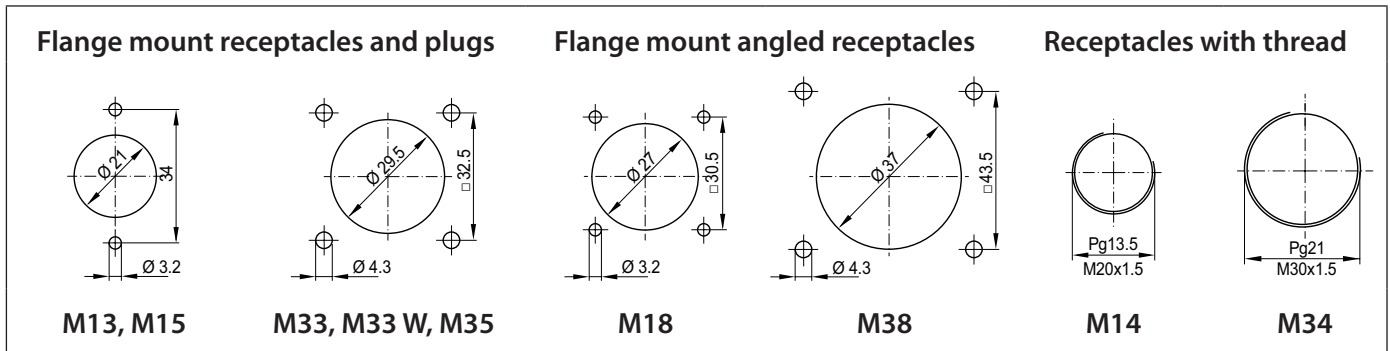

Fig. 1: Dimensions and arrangements of the mounting holes and threads (measures in mm)

6. Cable Assembly and Processing

6.1 Required Tools



Fig. 2: Insertion tools for socket inserts

► Insertion tools for socket inserts

Ordering code	Insertion tools for
VW-M1 E-4S	Contact insert M1 E-4S+PE
VW-M1 E-6S	Contact insert M1 E-6S+PE
VW-M3 E-6S	Contact insert M3 E-6S+PE
VW-M3 E-5S+3S	Contact insert M3 E-5S+3S+PE
VW-M3 E-12S	Contact insert M3 E-12S+PE, M3 7+7S+PE



Fig. 3: Insertion tools for pin inserts

► Insertion tools for pin inserts

Ordering code	Insertion tools for
VW-M1 E-4P	Contact insert M1 E-4P+PE
VW-M1 E-6P	Contact insert M1 E-6P+PE
VW-M3 E-6P	Contact insert M3 E-6P+PE
VW-M3 E-5P+3P	Contact insert M3 E-5P+3P+PE
VW-M3 E-12P	Contact insert M3 E-12P+PE, M3 7+7P+PE



Fig. 4: Extraction tool

► Extraction tools for disassembly of contacts

Ordering code	Extraction tools for
AWZ-A	Contacts type SAC-x
AWZ-B	Contacts type SBC-x, BBC-x
AWZ-C/H	Contact type SCC-x, BCC-x

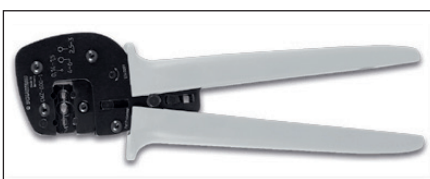

Fig. 5: Crimping pliers

► Crimping pliers

Ordering code	Crimping pliers for
CWZ-600-1	SAC-x, BAC-x, SBC-x, BBC-x, SCC-x and BCC-x, (not appropriate for contacts SAC-2.50-xx and BAC-2.50-xx)
Tool frame M22520/1-01 and Turret M22520/1-02 (without illustration)	For contacts SAC-2.50-xx and BAC-2.50-xx only. Crimping pliers and turret from the company DMC or the company Buchanan. Order directly from the manufacturer.

► Wire stripping tools, commercially available

► Tweezers, commercially available (for inserting filler plugs)

6.2 Crimp Contacts (Pin / Socket) and Filler Plugs

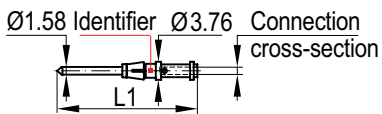
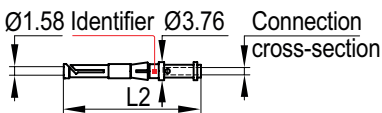
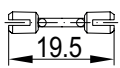
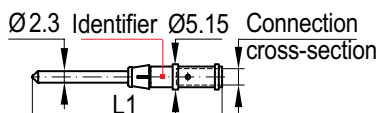
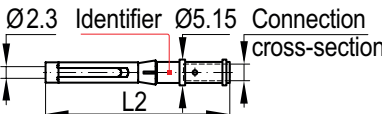
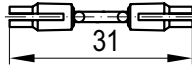
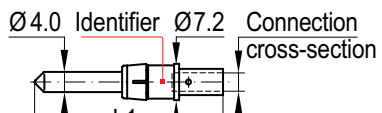
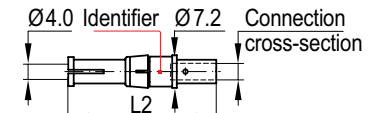
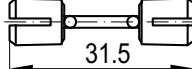
Contact type	Contact model	L1	L2	Identifier	Ordering code ¹⁾	Connection cross-section
Pin contact SAC-x Ø 1.58 mm		28.6	-	without groove 1 groove 2 grooves 3 grooves	SAC-0.50-Ag SAC-1.00-Ag SAC-1.50-Ag SAC-2,50-Ag	0.5 mm ² 0.75 ... 1 mm ² 1.5 mm ² 2.5 mm ²
Socket contact BAC-x Ø 1.58 mm		-	28.6	without groove 1 groove 2 grooves 3 grooves	BAC-0.50-Ag BAC-1.00-Ag BAC-1.50-Ag BAC-2.50-Ag	0.5 mm ² 0.75 ... 1 mm ² 1.5 mm ² 2.5 mm ²
Filler plug ²⁾ BS-A-V10		-	-	-	BS-A-V10	-
Pin contact SBC-x Ø 2.3 mm		40.4 40.4 40.4 39.0 39.0 39.0	-	without groove 1 groove 2 grooves 3 grooves 1 broad groove 2 broad grooves	SBC-0.50-Ag SBC-1.00-Ag SBC-1.50-Ag SBC-2.50-Ag SBC-4.00-Ag SBC-6.00-Ag	0.5 mm ² 1.0 mm ² 1.5 mm ² 2.5 mm ² 4.0 mm ² 6.0 mm ²
Socket contact BBC-x Ø 2.3 mm		-	37.0 37.0 37.0 35.6 35.6 35.6	without groove 1 groove 2 grooves 3 grooves 1 broad groove 2 broad grooves	BBC-0.50-Ag BBC-1.00-Ag BBC-1.50-Ag BBC-2.50-Ag BBC-4.00-Ag BBC-6.00-Ag	0.5 mm ² 1.0 mm ² 1.5 mm ² 2.5 mm ² 4.0 mm ² 6.0 mm ²
Filler plug ²⁾ BS-B-V10		-	-	-	BS-B-V10	-
Pin contact SCC-x Ø 4.0 mm		37.5 37.5 37.5	-	3 grooves 1 broad groove 2 broad grooves	SCC-2.50-Ag SCC-4.00-Ag SCC-6.00-Ag	2.5 mm ² 4.0 mm ² 6.0 mm ²
Socket contact BCC-x Ø 4.0 mm		-	32.6 32.6 32.6	3 grooves 1 broad groove 2 broad grooves	BCC-2.50-Ag BCC-4.00-Ag BCC-6.00-Ag	2.5 mm ² 4.0 mm ² 6.0 mm ²
Filler plug ²⁾ BS-C-V10		-	-	-	BS-C-V10	-

1) The standard contact surface for pin and socket contacts is silver (AG). For gold plated contacts (AU) please change the contact surface from "AG" to "AU" in the ordering code.

2) Filler plugs serve as an equipment of not configured contact cavities in the contact inserts:

- For socket inserts: A whole filler plug is inserted into every not configured contact cavity.
- For pin inserts: A whole filler plug is cutted in the middle and only half a filler plug is inserted into every not configured contact cavity.

6.3 Ordering Code for Contacts

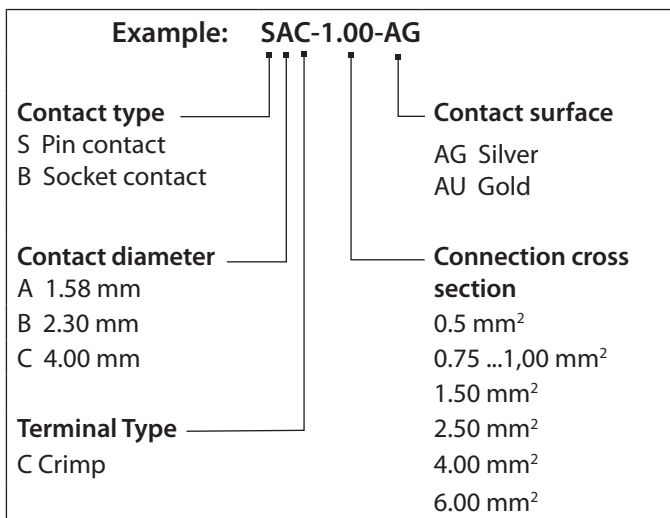

6.4 Threading Parts on Cables

The following illustrations show for some examples how the connector parts have to be threaded on the cables.

Plugs / receptacles for cables

Depending on the application, at first thread all parts (1 to 6) on the cable.

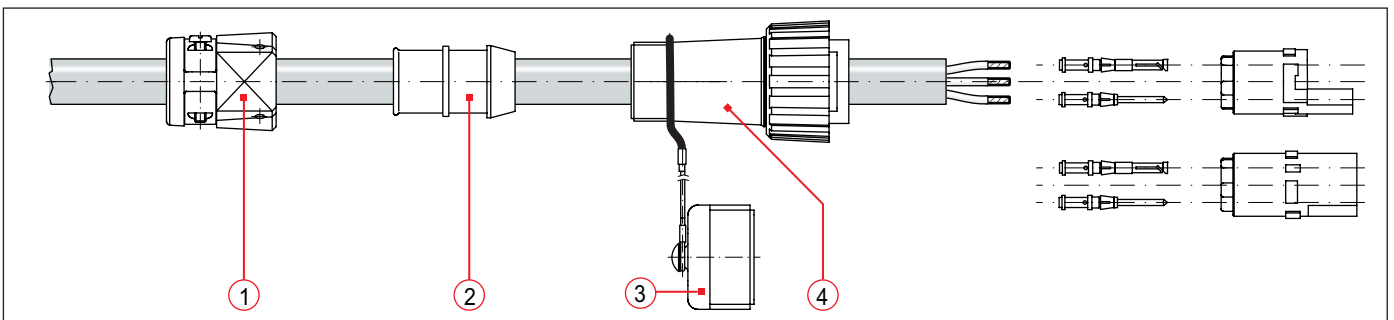

Fig. 6: Example for plug with back shell, strain relief and cable gland (applies also for cable receptacles)

- 1 Back shell with strain relief and cable gland
- 2 Cable sleeve with pre-assembled pressure disc
- 3 Protection cap for plugs or receptacles respectively
- 4 Plug or receptacle shell respectively

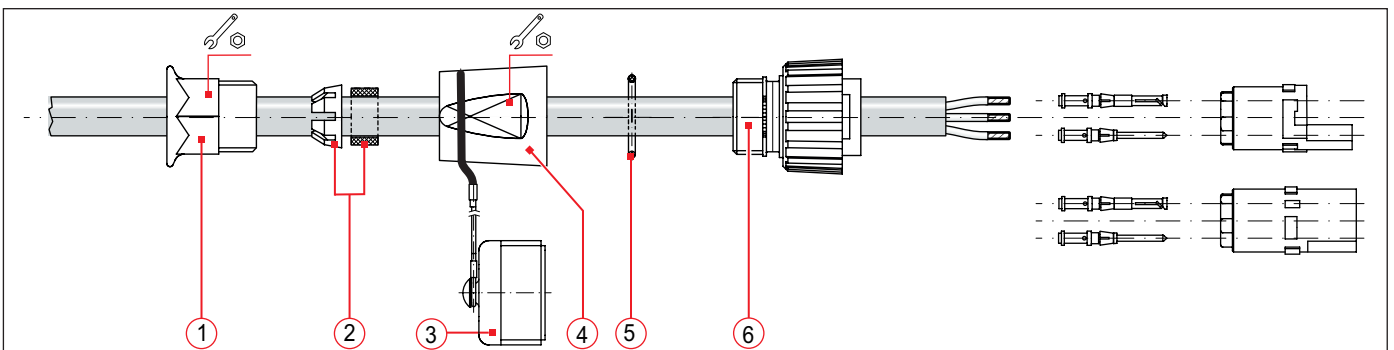

Fig. 7: Example for plug with thread, back shell and cable gland (applies also for receptacles with thread)

- | | |
|--|---|
| 1 Cable gland | 4 Back shell |
| 2 Strain relief with rubber ring | 5 O-ring |
| 3 Protection cap for plugs or receptacles respectively | 6 Plug or receptacle shell respectively |

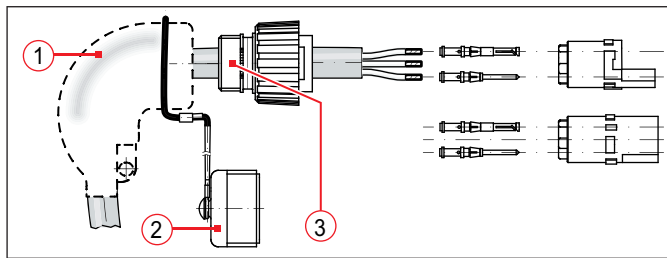

















Fig. 8: Example for plug with threaded rear skirt and 90° shrink boot (applies also for receptacles with thread)

- 1 Shrink boot 90°
- 2 Protection cap for plugs or receptacles respectively
- 3 Plug or receptacle shell respectively

Protection caps for cable receptacles and cable plugs

The following table shows, how protection caps with cords or plastic clips have to be threaded properly on the different cable receptacles and cable plugs.

Protection caps for cable receptacles		Protection caps for cable plugs		
M1 series	 M14 with cord	 M14 with plastic clip	 M16 with cord	 M16 with plastic clip
	 M11 with cord	 M11 with plastic clip	 M16 W with back shell with cord	 M16 W with back shell with plastic clip
M3 series	 M31 mit Schnur	 M31 with plastic clip	 M36 with cord	 M36 with plastic clip
	 M34 with cord	 M34 with plastic clip	 M36 W with back shell with cord	 M36 W with back shell with plastic clip

Plugs / receptacles with flange for wall assembly

- ▶ Slide the cable from the rear through the mounting wall (8).
- ▶ Thread the plug / receptacle with flange (9) on the cable and mount the flange with the fastening screws on the mounting wall (8) with the prepared mounting hole.
- ▶ In doing so, also screw on protection cap (10) with one of the fastening screws on the flange (11).
- ▶ For the assembly use
 - M3 screws for M1 series,
 - M4 screws for M3 series.

The torque for the fastening screws is in both series 2.5 Nm.

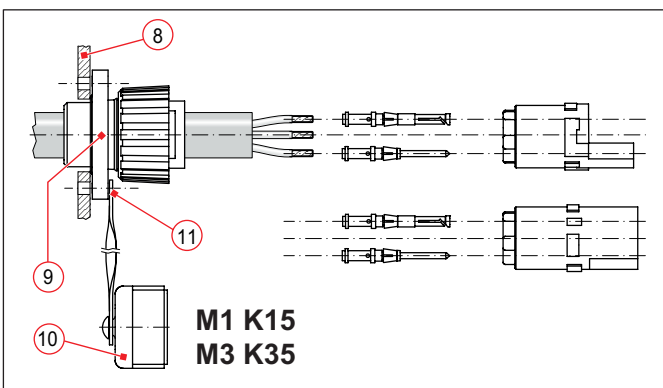

Fig. 9: Example of assembly for flange mount plugs on a mounting wall (applies also for receptacles with flange)

Plugs / receptacles with thread for wall assembly

NOTICE

Loctite 5331 threadlocker is to be used for the plugs/receptacles with thread for wall assembly.

- ▶ Slide the cable from the rear through the mounting wall (12).
- ▶ Thread the protection cap (14) on the thread side onto the plug/receptacle (13).
- ▶ Thread the plug/receptacle with thread (13) onto the cable.
- ▶ Apply Loctite 5331 to the thread (15) and screw the plug/receptacle into the mounting wall furnished with the same thread.

The torque for all receptacles with thread is 2.5 Nm.

For the assembly of the contacts and contact inserts refer to section „6.6 Assemble Contacts into Contact Inserts“ und „6.8 Assemble Contact Inserts into Receptacle / Plug shells“.

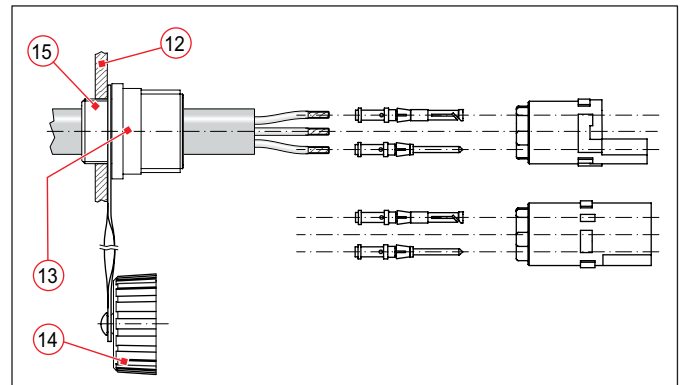

Fig. 10: Example of assembly for receptacles with thread on a mounting wall (applies also for plugs with thread)

6.5 Make Crimp Connections

The connection of the crimp contacts has to be made according to DIN EN 60352-2 – Solderless Connections. In order to comply with DIN EN IEC 61984 make sure that always the live side of the connector – no matter whether plug or receptacle – is fitted with socket contacts.

For all contact inserts observe the following:

- for pin inserts a socket contact must be used for the protective earthing (PE) contact,
- for socket inserts a pin contact must be used for the protective earthing (PE) contact.

Assembly

- ▶ Disengage the cable at the connection end from the coating and strip cable strands approx. 7 mm.
- ▶ Push the cable strands into the contacts.
- ▶ Crimp the cable strands to the contacts using the crimping pliers.
 - In doing so, observe connection cross-section of contacts depending on the model of the crimp contacts (refer to section “6.2 Crimp contacts (pin / socket) and filler plugs”).
 - Crimping must be made in the centre between the sight drill hole and the end of the contact.

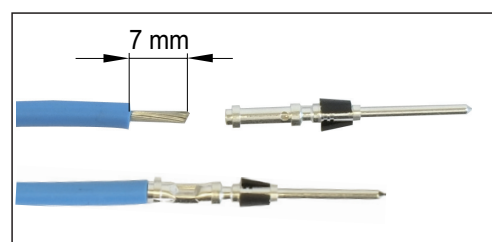



Fig. 11: Skin cable strands and crimp to contacts.

Check

- ▶ Check if crimp contacts are firmly and correctly connected.
 - Make sure that no single wires stick out. Check extraction forces according to DIN EN 61238-1.

6.6 Assemble Contacts into Contact Inserts

After all the cable strands have been crimped with the contacts and have been checked for firm and correct connection, the contacts may be assembled into the contact inserts.

	⚠ WARNING
	<p>A wrong pin configuration of the contact inserts may cause a deadly electric shock.</p> <ul style="list-style-type: none"> ▶ Make sure that associated pin and socket contacts are always inserted into the corresponding contact cavities with identical pin configuration! ▶ Make sure that contacts with phase assignment are not mounted into contact cavities which are destined for the protective earthing (PE)!

Assembly

- ▶ Inserting of the contacts (1) into the contact insert (2) is made starting from the middle outwards: In doing so, push every single contact to limit stop into the contact insert until the contact locks audibly.
- ▶ Insert filler plugs from the plug side into the contact insert of not configured contact cavities, refer to section „6.7 Assemble Filler Plugs“.

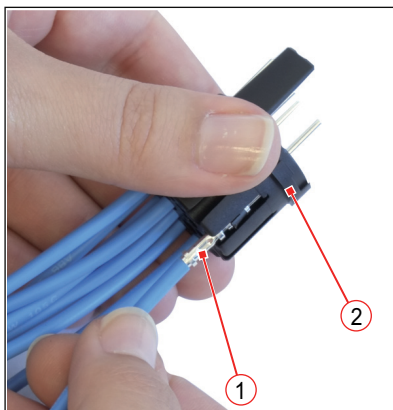

Fig. 12: Pushing contacts (1) into contact inserts (2)

Check

- ▶ Check if all contacts are firmly in place: test force 40 N.

Disassembly

- ▶ In order to remove contacts from the contact inserts, adequate extraction tools are needed, refer to section „6.1 Required Tools“.
- ▶ Attach the extraction tool (3) to the contact (4) and extract the contact from the contact insert.

NOTICE

After a contact has been extracted, the interlock function of the plastic clip (5) is no longer guaranteed. When the contact is reused, a new plastic clip – fitting for the type of contact – must be used! (Refer to chapter „9. Special Tools and Spare Parts“)

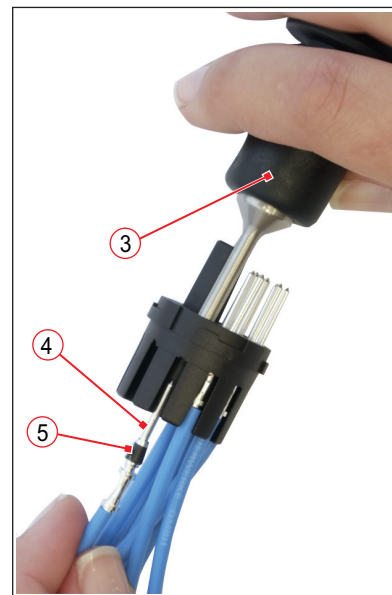

Fig. 13: Disassembling of contacts (4) with extraction tool (3). When using the contact again a new plastic clip (5) is absolutely necessary.

6.7 Assemble Filler Plugs

Filler plugs have to be inserted into not configured contact cavities of the contact inserts. Depending on the contact insert, filler plugs of different models and with corresponding diameters are available, refer to section „6.2 Crimp Contacts (Pin/Socket) and Filler Plugs“.

The following illustrations show for different examples of application how filler plugs have to be assembled into the contact inserts.

- ▶ Use tweezers (2) for easier insert of small filler plugs (1).

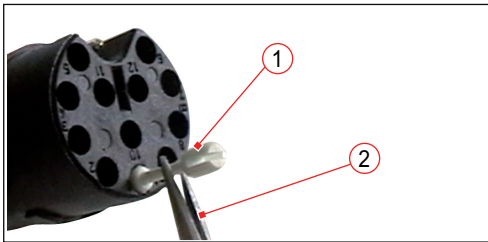

Fig. 14: Insert of small filler plugs (1) (e. g. BS-A/BS-B) with tweezers (2)

For socket inserts:

- ▶ Insert one whole filler plug (1/3) per not configured contact cavity.

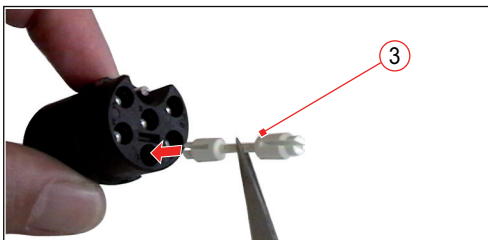

Fig. 15: Assembly of whole filler plugs (3) for socket inserts

For pin inserts:

- ▶ Cut through one whole filler plug in the middle and only insert half a filler plug (4) per not configured contact cavity.

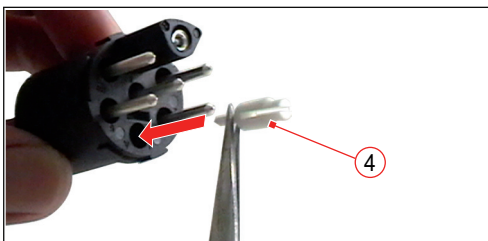

Fig. 16: Assembly of half filler plugs (4) for pin inserts

- ▶ Insert the filler plug from the plug side into the contact insert and push until the end stop.

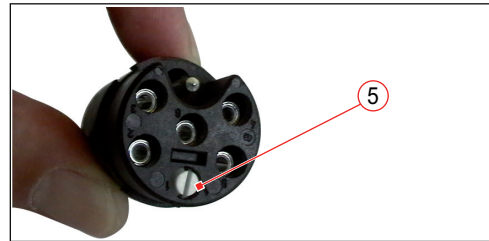

Fig. 17: Final position (5) of the assembled filler plug

6.8 Assemble Contact Inserts into Receptacle / Plug shells

After all the contacts have been made and the contacts and the filler plugs, if necessary, have been assembled into the contact insert, the contact insert must be inserted into the shell and locked with the help of adequate insertion tools (refer to section „6.1 Required Tools“).

Codings

The receptacle and plug shells as well as the corresponding contact inserts are equipped with codings in the form of grooves and guideways.

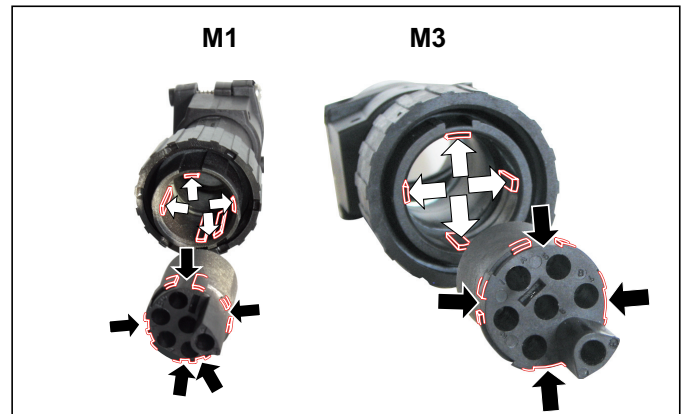

Fig. 18: Examples for codings: Grooves on the contact inserts, guideways on the inner sides of the shells



All contact inserts have 2 coding positions (A, B). This allows for the unmistakable connection of for example two connectors with different voltages to one and the same piece of equipment.

In the following table, the coding positions A and B are illustrated for the different contact inserts. The illustrations refer respectively to the mounting position of the corresponding contact insert.

During assembly, the contact inserts must be pressed downwards in an axial direction into the housing with the fitting insertion tool up to the detectable mechanical stop. (This equates to overriding the corrugated spring up to the mechanical stop.)

In this pressed position, turn the contact insert in a clockwise direction to the final position.

The insertion tool must be brought out in this position. The contact insert is then pushed up by the corrugated spring up to the stop.

	Coding position A		Coding position B (rotated by 90° from coding position A)	
	Pin inserts	Socket inserts	Pin inserts	Socket inserts
Series M1	 M1 E-4P+PE	 M1 E-4S+PE	 M1 E-4P+PE	 M1 E-4S+PE
	 M1 E-6P+PE	 M1 E-6S+PE	 M1 E-6P+PE	 M1 E-6S+PE
Series M3	 M3 E-6P+PE	 M3 E-6S+PE	 M3 E-6P+PE	 M3 E-6S+PE
	 M3 E-5P+3P+PE ¹⁾	 M3 E-5S+3S+PE ¹⁾	 M3 E-5P+3P+PE ¹⁾	 M3 E-5S+3S+PE ¹⁾
	 M3 E-12P+PE	 M3 E-12S+PE	 M3 E-12P+PE	 M3 E-12S+PE
	 M3 E-7P+7P+PE	 M3 E-7S+7S+PE	 M3 E-7P+7P+PE	 M3 E-7S+7S+PE
	 M3 E-7P+7P+PE	 M3 E-7S+7S+PE	 M3 E-7P+7P+PE	 M3 E-7S+7S+PE

1) **Note:** For the contact inserts M3 E-5P+3P+PE and M3 E-5S+3S+PE, the designations of the coding positions "A" and "B" are not printed on the contact insert.

Assembly

- ▶ Insert the completely wired contact insert (1) in desired coding position (A or B) with the grooves into the guideways of the shell (2) and push the contact insert into the shell.
- ▶ Put on fitting insertion tool (3) and press the contact insert downwards in an axial direction up to the detectable mechanical stop (4-1). (This equates to overriding the corrugated spring up to the mechanical stop.)
- ▶ In this pressed position, turn the contact insert in a **clockwise direction** to the **final position** (4-2).
- ▶ Bring the insertion tool out in this position. The contact insert is then pushed up by the corrugated spring up to the stop.

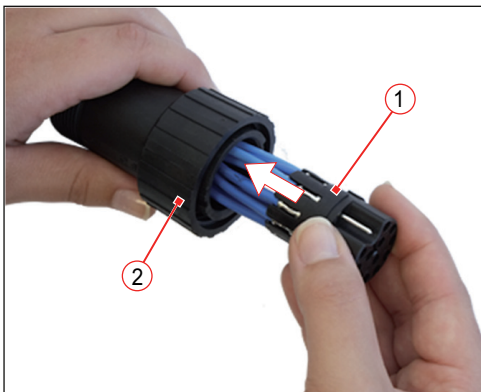

Fig. 19: Assemble contact insert into the shell using the insertion tool

Check

- ▶ Check if all contact inserts are locked correctly and properly in place.

Disassembly

- ▶ Put on fitting insertion tool (3) and press the contact insert downwards in an axial direction up to the detectable mechanical stop. (This equates to overriding the corrugated spring up to the mechanical stop.)
- ▶ In this pressed position, turn the contact insert **anticlockwise** up to the **mounting position**.
- ▶ Bring out the insertion tool together with the contact insert in this position.

6.9 Final Assembly of the Connectors

After the completely wired contact inserts have been assembled into the receptacle/plug shell and have been checked whether they are locked correctly and properly in place, the final assembly of the connectors may be made.

The following illustrations show for some examples of application how the final assembly of the connector parts is made.

Final assembly of cable plugs / cable receptacles

- ▶ Push the cable sleeve (8) into the shell (9).
- ▶ Screw together the strain relief (7) with the plug / receptacle shell (9).
- ▶ Accomplish the strain relief by tightening the two screws (5). Tightening torque: 2.5 Nm
- ▶ Attach the protection cap (10) to the plug / receptacle shell (9) and screw down the cap.

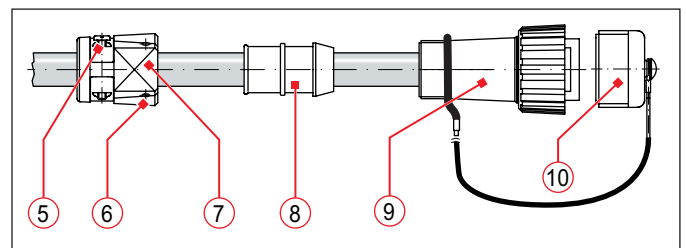

Fig. 20: Example for cable plugs with back shell, strain relief and cable gland (applies also for cable receptacles)

Only for shells M11 Z, M16 Z, M31 Z, M36 Z:

In order to achieve an additional protection against twisting for the strain relief (7), 2 self-tapping screws may be screwed into the prepared drill holes (6) (the screws are not part of the shipment):

- for the shells M11 Z, M16 Z two self-tapping screws with cylinder head 2.2 x 9.5 are needed for this.
- for the shells M31 Z, M36 Z two self-tapping screws with cylinder head 2.9 x 13.

The tightening torque for the self-tapping screws is 2.5 Nm.

Final assembly of plugs / receptacles with thread

- ▶ Insert the O-ring (4) into the back shell (3).
- ▶ Screw together the back shell (3) with the plug / receptacle shell (6).
- ▶ Push the strain relief with the rubber ring (2) into the back shell (3).
- ▶ Screw together the cable gland (1) with the back shell (3).
- ▶ Attach the protection cap (5) to the plug / receptacle shell (6) and screw down the cap.

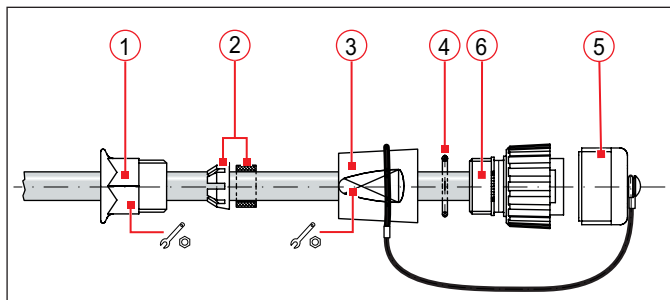

Fig. 21: Example for plug with thread, back shell and cable gland (applies also for receptacles with thread)

Final assembly of plugs / receptacles with thread and 90° shrink boot

- ▶ Push the shrink boot (7) onto the plug / receptacle shell (6) and shrink with the shaft of the shell.
- ▶ Attach the protection cap (5) to the plug / receptacle shell (6) and screw down the cap.

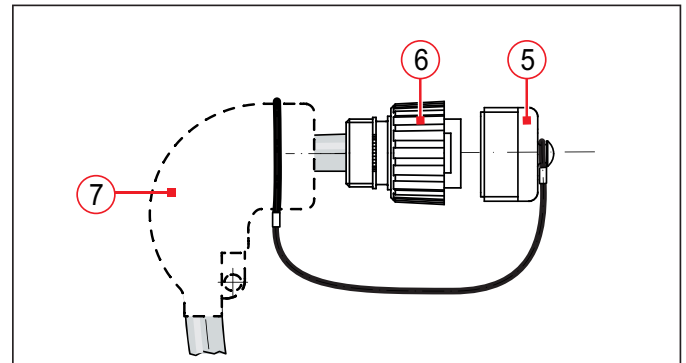

Fig. 22: Example for plug with thread and 90° shrink boot (applies also for receptacles with thread)

7. Plugging Procedure

NOTICE

Inappropriate handling when plugging or disconnecting may damage the connectors. The functional safety of the connectors is no longer guaranteed when parts are damaged.

- ▶ Make sure when plugging that grooves (1) and guideways (2) of plug and receptacle always interlock!
- ▶ Take care that plug and receptacle do not tilt and that they are plugged without force.
- ▶ Make sure before the plugging procedure that plug and receptacle as well as the protection caps are not soiled. Remove existent dirt without leaving any residue.
- ▶ Make sure that in the not mated condition the protection caps are always attached according to regulations.



Note:

In case of a very low or very high ambient temperature which approximates the limits of the allowable operating temperature range specified in our catalogue *A10.en* in section "Specifications",

- a higher effort may be needed for the plugging and unplugging and
- the operational life span of plug and coupling receptacle may thus be reduced due to increased wear and tear.

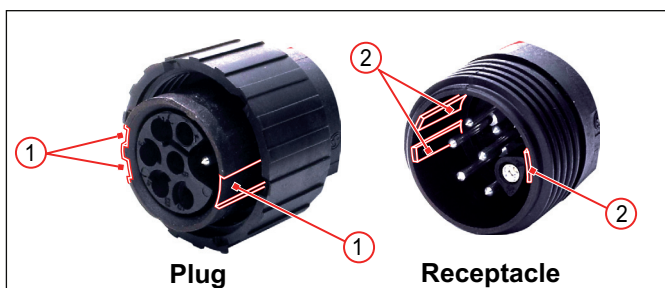

Fig. 23: Series M1: Grooves (1) on plug and guideways (2) on receptacle

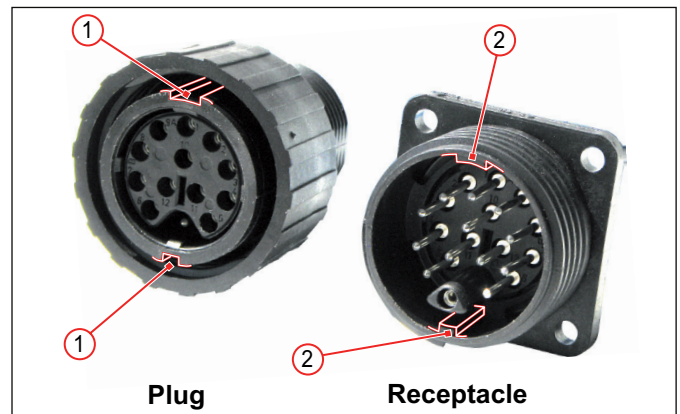

Fig. 24: Series M3: Grooves (1) on plug and guideways (2) on receptacle

7.1 Plugging

- ▶ Screw off the protection cap and slide it off the plug or receptacle respectively.
- ▶ Attach the plug (3) in such a way to the receptacle (4) that the different grooves (1) in the plug lie superposable to the guideways (2) of the receptacle. For this purpose turn the plug slightly to and fro, if necessary, until the grooves and guideways slide into each other without force.



Fig. 25: Connect plug (3) and receptacle (4) in such a way that grooves and guideways slide into each other easily

- ▶ Screw the union nut (5) of the plug on the receptacle. In doing so, take care not to tilt the thread and that the union nut can be screwed easily.
- ▶ Screw down the union nut (5) of the plug hand-tight.



Fig. 26: Screw union nut (5) on thread of receptacle

- ▶ Check that the connector is connected correctly. For this purpose, control the gap between union nut and receptacle shell on the basis of the nominal sizes indicated in the following table.

Type of receptacle	Nominal sizes for the gap between union nut and receptacle shell when the connection is correctly screwed	
	M1	M3
Cable receptacles	approx. 3 mm 	approx. 3 mm
Receptacles with flange	approx. 3 mm 	approx. 3 mm
Flange mount angled receptacles	approx. 15 mm 	approx. 10 mm
Receptacles with thread	approx. 4 mm 	approx. 3 mm
Receptacles for shrink boot	---	approx. 3 mm

7.2 Unplugging

- ▶ Screw off the union nut (5) of the plug (3) from the receptacle (4) and take off the plug.
- ▶ Close plug and receptacle with the protection caps, refer to „7.3 Attach Protection Caps“.



Fig. 27: Screw off union nut (5)



Fig. 28: Slide off plug (3) from receptacle (4)

7.3 Attach Protection Caps

In order to meet the requirements of the protection class and to prevent the connectors against the entry of dirt or moisture, make sure that plugs and receptacles, when not mated, are always closed with protection caps.

- ▶ Make sure that the protection caps are free of dirt and deposits.

Close plug with protection cap

- ▶ Attach the protection cap (6) in such a way to the plug that the grooves lie superposable to the guideways. If necessary, turn the cap slightly to and fro until the grooves and guideways slide into each other without force.

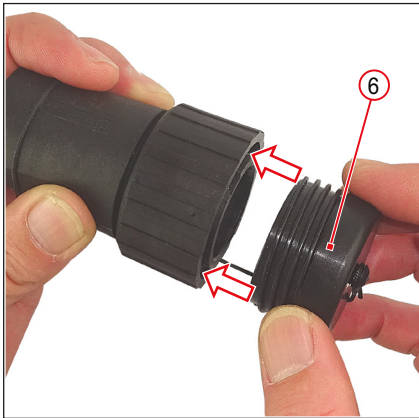

Fig. 29: Attach protection cap (6) to the plug

- ▶ Screw down the union nut (5) of the plug hand-tight.

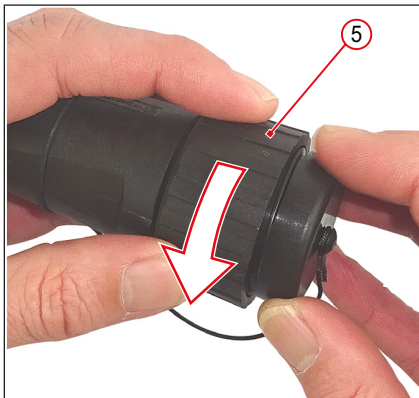
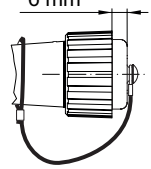
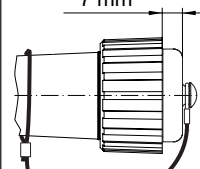
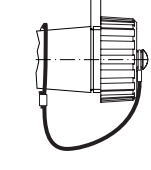
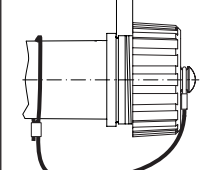

Fig. 30: Screw down union nut (5) hand-tight

- ▶ Check that the protection cap has been screwed correctly. For this purpose, control the gap between union nut and protection cap on the basis of the nominal sizes indicated in the following table.

Close receptacle with protection cap

- ▶ Attach the protection cap to the receptacle and screw down hand-tight.
- ▶ Check that the protection cap has been screwed correctly. For this purpose, control the gap between protection cap and receptacle shell on the basis of the nominal sizes indicated in the following table.

Type of protection cap	Nominal sizes for protection caps when cap has been screwed correctly	
	M1	M3
Protection cap (for plugs)	approx. 6 mm 	approx. 7 mm 
Protection cap (for receptacles)	approx. 5 mm 	approx. 6 mm 

8. Regular Visual Checks / Functional Checks

Please observe the expert knowledge absolutely required for maintenance under chapter „2. General and Security Information“.

	<p>⚠ DANGER</p>
	<p>The connectors contain components that carry voltage. Deadly hazard! Always observe the following safety regulations before beginning any work on electrical constructions:</p> <ul style="list-style-type: none"> ▶ Disconnect ▶ Ensure that it is not possible to reconnect unintentionally ▶ Clearly mark your work area ▶ Make sure that there is no voltage present ▶ Earth and short circuit the installation ▶ Insulate or cover adjacent energized parts ▶ Only an electrically skilled person may determine if there is no voltage present

8.1 Checking Intervals

The condition of the connectors depends on the ambient conditions. In order to safeguard the correct functioning and a prolonged operational life span of the connectors, the following visual and functional checks have to be performed regularly.

Visual check / functional check	Interval
Check of - Plugs - Wire - Receptacles - Union nut - Contacts - Contact insert - Shrink boot - Backshell - Cable gland/Strain relief - Protection caps - Guideways / grooves of the coding in plug and receptacle shells	▶ With every plugging procedure

8.2 Visual and Functional Check with Every Plugging Procedure

All elements of the connectors have to undergo a visual and functional check with every plugging procedure.

<p>NOTICE</p>
<p>If damages are visible on wire, plug, receptacle, contacts, contact inserts or on any other element of the connectors, the functional safety of the connectors is no longer guaranteed.</p> <p>▶ Immediately replace all damaged parts.</p>

Connector element	Visual and functional check	Measures
Plug	Check for: <ul style="list-style-type: none"> ▶ ease of movement when plugging ▶ dirt ▶ damage or wear and tear on shell, contacts, contact insert ▶ damage or wear and tear on grooves / guideways (e.g. round edges) ▶ bent contacts ▶ loose or missing fastening elements ▶ cracks and ruptured patches 	In the case of defects: <ul style="list-style-type: none"> ▶ remove existent dirt (abrasion of the contact surface) without leaving any residue ▶ immediately replace damaged parts
Union nut on plug	Check for: <ul style="list-style-type: none"> ▶ ease of movement when unscrewing and screwing down ▶ dirt ▶ damage or wear and tear of the thread ▶ cracks and ruptured patches 	In the case of defects: <ul style="list-style-type: none"> ▶ remove existent dirt without leaving any residue ▶ when the union nut is damaged, immediately replace the complete plug shell
Receptacle	Check for: <ul style="list-style-type: none"> ▶ ease of movement when plugging ▶ dirt ▶ damage or wear and tear on shell, contacts, contact insert ▶ bent contacts ▶ damage or wear and tear on grooves / guideways (e.g. round edges) ▶ loose or missing fastening elements ▶ damage or wear and tear of the thread ▶ cracks and ruptured patches 	In the case of defects: <ul style="list-style-type: none"> ▶ remove existent dirt (abrasion of the contact surface) without leaving any residue ▶ immediately replace damaged parts
Backshell/strain relief, shrink boot, cable gland	Check for: <ul style="list-style-type: none"> ▶ dirt ▶ damage or cracks on shell, shrink boot, cable gland ▶ loose or missing fastening elements ▶ proper fastening and correct fitting ▶ correct functioning of strain relief 	In the case of defects: <ul style="list-style-type: none"> ▶ remove existent dirt without leaving any residue ▶ immediately replace damaged parts
Protection caps	Check for: <ul style="list-style-type: none"> ▶ ease of movement when unscrewing and screwing down ▶ dirt ▶ damage or wear and tear on the thread ▶ damage or wear and tear on grooves / guideways (e.g. round edges) ▶ worn out fastening cord or damaged plastic clip ▶ cracks and ruptured patches ▶ damaged sealing ring in protection cap 	In the case of defects: <ul style="list-style-type: none"> ▶ remove existent dirt without leaving any residue ▶ immediately replace damaged parts

9. Special Tools and Spare Parts

Special tools	Ordering code
Extraction tools for disassembling of contacts: <ul style="list-style-type: none"> - for contact type SAC-x, BAC-x - for contact type SBC-x, BBC-x - for contact type SCC-x, BCC-x 	AWZ-A AWZ-B AWZ-C/H
Insertion tools for socket inserts: <ul style="list-style-type: none"> - for contact insert M1 E-4S+PE - for contact insert M1 E-6S+PE - for contact insert M3 E-6S+PE - for contact insert M3 E-5S+3S+PE - for contact insert M3 E-12S+PE, M3 7+7S+PE 	VW-M1 E-4S VW-M1 E-6S VW-M3 E-6S VW-M3 E-5S+3S VW-M3 E-12S
Insertion tools for pin inserts: <ul style="list-style-type: none"> - for contact insert M1 E-4P+PE - for contact insert M1 E-6P+PE - for contact insert M3 E-6P+PE - for contact insert M3 E-5P+3P+PE - for contact insert M3 E-12P+PE, M3 7+7P+PE 	VW-M1 E-4P VW-M1 E-6P VW-M3 E-6P VW-M3 E-5P+3P VW-M3 E-12P

Spare parts	Ordering code
Plastic clips: <ul style="list-style-type: none"> - for contact type SAC-x, BAC-x - for contact type SBC-x, BBC-x - for contact type SCC-x, BCC-x 	Clip for contact type A Clip for contact type B Clip for contact type C

10. Technical Data

Specifications and information on the material characteristics for the connectors of the M series are given in our catalogue **A10.en**.

Due to our continuous improvement programme, the design of our products can be modified at any time. So some features may differ from the descriptions, specifications and drawings in the catalogue. You can download the latest update of the catalogue at: schaltbau.info/download1en. The updated catalogue renders the previous issue invalid.

Schaltbau GmbH

For detailed information on our products and services visit our website – or give us a call!

Schaltbau GmbH
Hollerithstrasse 5
81829 Munich
Germany



Phone +49 89 9 30 05-0
Fax +49 89 9 30 05-350
Internet www.schaltbau.com
e-Mail contact@schaltbau.de

with compliments:



The production facilities of Schaltbau GmbH have been IRIS certified since 2008.



Certified to DIN EN ISO 14001 since 2002. For the most recent certificate visit our website.



Certified to DIN EN ISO 9001 since 1994. For the most recent certificate visit our website.

Electrical Components and Systems for Railway Engineering and Industrial Applications

Connectors

- Connectors manufactured to industry standards
- Connectors to suit the special requirements of communications engineering (MIL connectors)
- Charging connectors for battery-powered machines and systems
- Connectors for railway engineering, including UIC connectors
- Special connectors to suit customer requirements

Snap-action switches

- Snap-action switches with positive opening operation
- Snap-action switches with self-cleaning contacts
- Snap-action switch made of robust polyetherimide (PEI)
- Snap-action switch with two galvanically isolated contact bridges
- Special switches to suit customer requirements

Contactors Emergency disconnect switches

- Single and multi-pole DC contactors
- High-voltage AC/DC contactors
- Contactors for battery powered vehicles and power supplies
- Contactors for railway applications
- Terminal bolts and fuse holders
- DC emergency disconnect switches
- Special contactors to suit customer requirements

Electrics for rolling stock

- Equipment for driver's cab
- Equipment for passenger use
- High-voltage switchgear
- High-voltage heaters
- High-voltage roof equipment
- Equipment for electric brakes
- Design and engineering of train electrics to customer requirements